

Grow-with-Me
Crib Conversion Kits



THE PRODUCT IMAGES SHOWN ARE FOR ILLUSTRATION PURPOSES ONLY
AND MAY NOT BE AN EXACT REPRESENTATION OF YOUR CRIB.

IMPORTANT INFORMATION:
READ ALL INSTRUCTIONS BEFORE ASSEMBLING BED.
KEEP INSTRUCTIONS FOR FUTURE USE.

ASSEMBLY INSTRUCTIONS

TODDLER KIT

TOOLS NEEDED FOR ASSEMBLY



CAUTION: POWER TOOLS ARE NOT RECOMMENDED, AS THEY CAN CAUSE THE WOOD TO SPLIT.

PARTS ENCLOSED

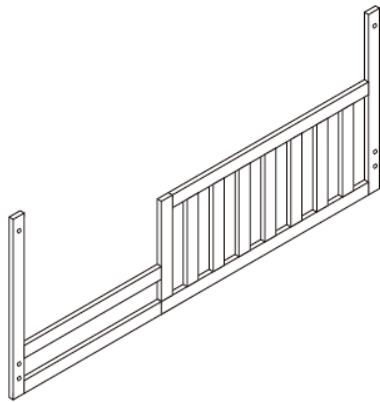

TODDLER RAIL
(2 PARTS)

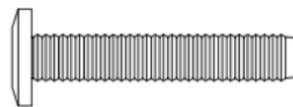

B. BOLTS (4)



C. SPRING WASHER (4)

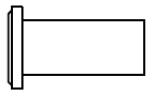

D. NUT (4)



E. ALLEN WRENCH



G. BOLT (1)



H. BARREL NUT (1)



L. WOODEN DOWEL (1)

STEP 1. REMOVE THE FOOTBOARD.

THE MATTRESS SUPPORT MUST BE IN THE LOWEST POSITION.

BE SURE TO KEEP THE EXTRA BOLTS AND BARREL NUTS FOR FUTURE USE.

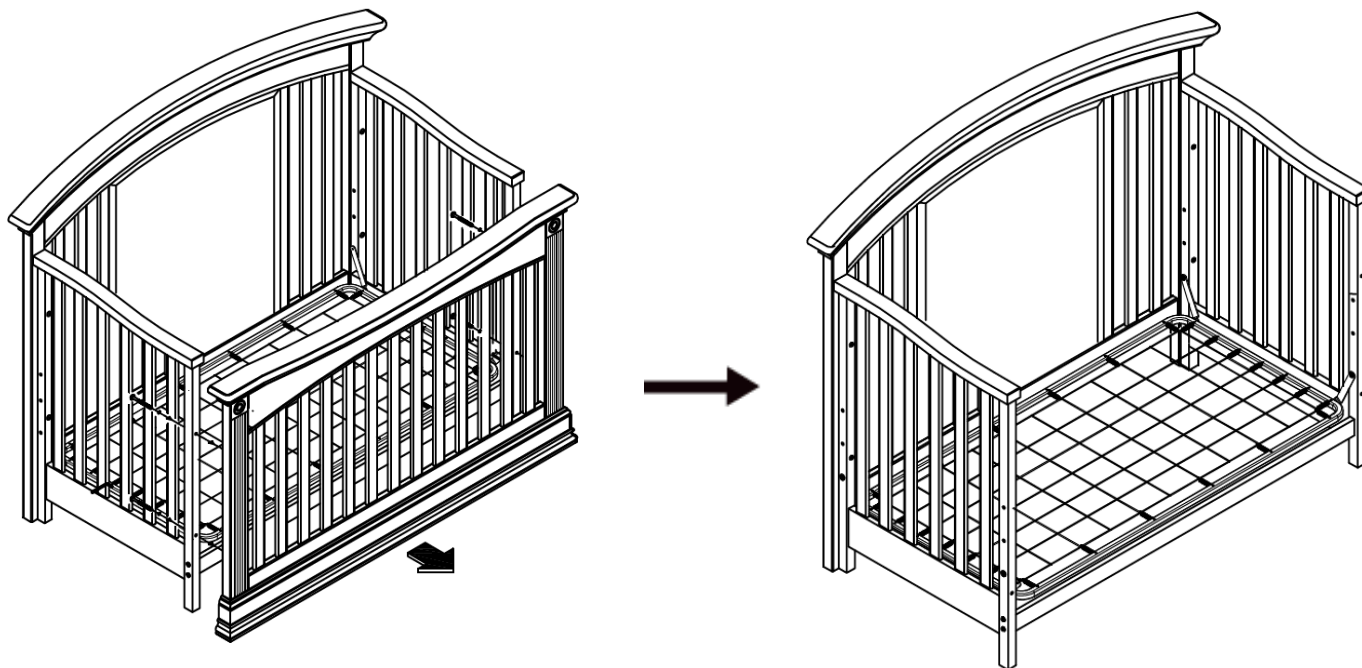

STEP 2. ATTACH THE TODDLER RAIL PARTS.

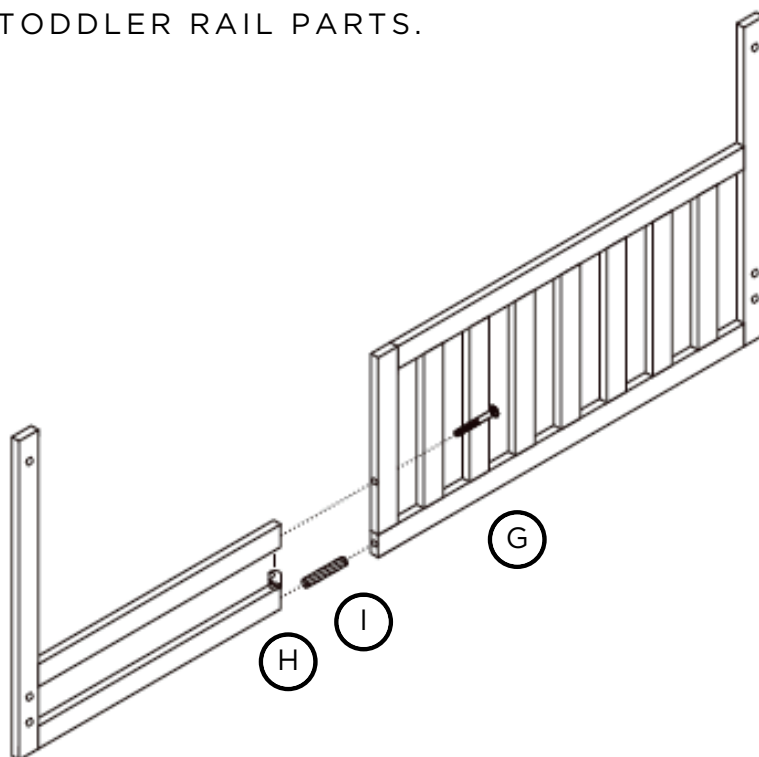

STEP 3. ATTACH TODDLER RAIL TO CRIB.

YOU CAN INSTALL THE TODDLER RAIL WITH THE OPENING ON EITHER END.

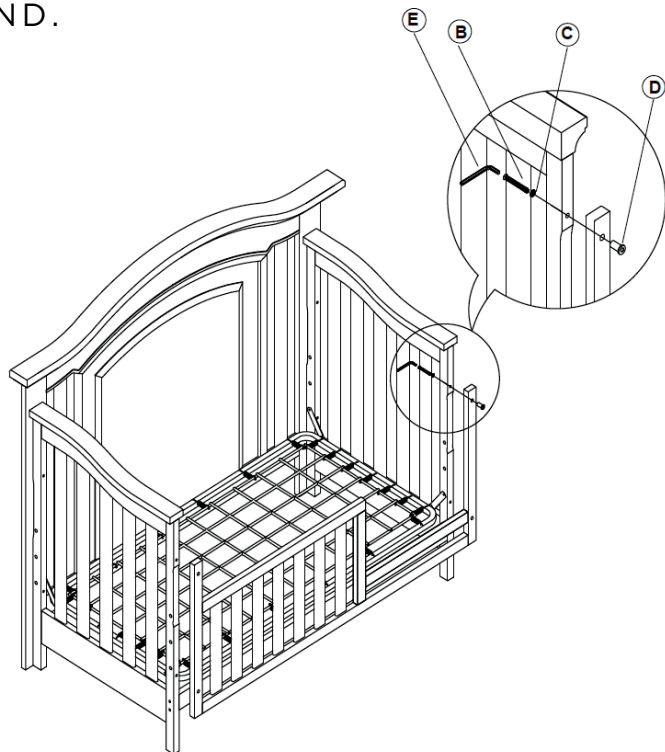

USE WITH OPENING ON LEFT OR RIGHT SIDE

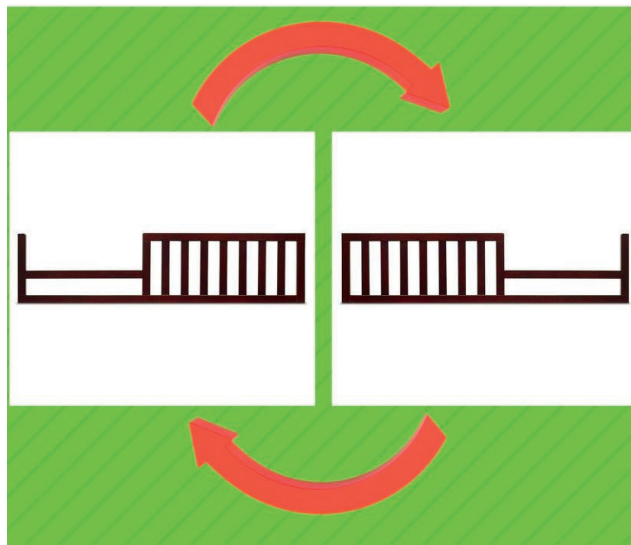

AVAILABLE ADD-ONS



SCAN ME

FULL SIZE CONVERSION KITS

- USE YOUR CAMERA TO SCAN THE QR CODE TO PURCHASE YOUR MATCHING CONVERSION KIT.
- BUY NOW TO HAVE LATER, WHEN YOU ARE READY TO CONVERT TO A FULL SIZE BED.

ABOUT US

In 2015, while looking for a conversion kit for our son's crib, we discovered that his crib had been discontinued. It was nearly impossible to locate the conversion kit in order to convert his crib to a full size bed. After speaking with many parents, we realized we were not the only ones with this problem. We had spent so much money on his crib (and matching furniture) in hopes of converting it one day. When we did eventually find a kit, we discovered that the kit was poor quality and made from PLYWOOD. Really? We did not feel comfortable allowing our son to sleep on his new bed. So we vowed to make it easier for other parents by providing our customers with quality conversion kits made of 100% SOLID WOOD! Hence, Grow-with-Me Crib Conversion Kits was born.



LEAVE US A REVIEW

I am so pleased with this product. I was amazed at the quality of the bed. Thank you, Crib Conversion Kits!

ALEC



THANK YOU FOR YOUR PURCHASE. WE HOPE YOU LOVE IT! IF YOU DO, WOULD YOU MIND TAKING 60 SECONDS TO POST A REVIEW? THIS HELPS US TO CONTINUE PROVIDING GREAT PRODUCTS AND HELPS POTENTIAL BUYERS MAKE CONFIDENT DECISIONS. WE KNOW LIFE IS BUSY, AND WE THANK YOU IN ADVANCE FOR YOUR REVIEW.